



Step-by-Step Instructions for

Making a Traditional Box Pleated Kilt

A supplement to the book *The Art of Kiltmaking*
by Barbara Tewksbury and Elsie Stuehmeyer

Barbara Tewksbury • Matthew Newsome

Copyright © 2008 Celtic Dragon Press
Design and illustrations: Barbara Tewksbury
Photography: Dave Tewksbury

You may share this document freely in its current form if you do so in its entirety. You may not, however, alter the document, take pieces of the document or illustrations from the document and reproduce or transmit them in any form, post them on the web, or use them in other documents without prior written permission from the copyright holder. In addition, the document may not be reproduced or transmitted in any form or by any means for commercial purposes without prior permission in writing. You may contact the copyright holder at <http://www.celticdragonpress.com>

Published by Celtic Dragon Press
P. O. Box 244
Deansboro, NY 13328

Cover page: Box pleated kilt in Scottish Odyssey tartan. Photograph by Dave Tewksbury.

Table of Contents

Acknowledgements	2
Introduction	3
Chapter 1 Supplement	
A brief history of traditional box pleated kilts	5
Chapter 4 Supplement	
Understanding the structure of a box pleated kilt	11
Chapter 5 Supplement	
Preparing to make a box pleated kilt	15
Chapter 7 Supplement	
Laying out a box pleated kilt and marking the tartan	17
Chapter 8 Supplement	
Preparing to sew a box pleated kilt	23
Chapter 9 Supplement	
Sewing a box pleated kilt	25
Appendix	
Making a comfortable thimble for kiltmaking	35
Making flashes from tartan scraps	36
About the Authors	37

****Please note:** This document is a supplement to the book *The Art of Kiltmaking*, by Barbara Tewksbury and Elsie Stuehmeyer. The table of contents above lists only those chapters for which the supplementary information in this document is relevant. This supplement will work equally well with both the 1st and 2nd printings of the book. If you do not have a copy of *The Art of Kiltmaking*, you can buy one at <http://www.celticdragonpress.com>

Acknowledgements

First and foremost, we are deeply indebted to kilt historian Bob Martin, who researched early kilt history and single-handedly resurrected this earliest style of tailored kilts. Without his passion, craftsmanship, and willingness to share his unique skill and deep knowledge, we would not be writing this set of how-to instructions.

Commercial photographer Dave Tewksbury was instrumental in producing the images for this book, and we are deeply grateful for his design insights, skill in scanning, and photographic acumen.

We would also like to thank Lt. Carolyn Tewksbury-Christle, who helped with the

cover design, and Kenneth Christle, who was our patient model.

And a big thank you to our many enthusiastic online friends at Xmarksthescot.com. They have patiently (mostly) waited for these instructions and are doing their part to preserve a tradition that is now over two centuries old.

And, finally, we would like to thank our families for putting up with our passions for kiltmaking, for the threads and pins that mark all the places we've been, and for understanding why we keep making kilts. Thank you Dave, Carolyn, Joannie, Abigail, Josiah, Malcolm, and Alister.

Introduction

The earliest tailored kilts dating from the end of the 1700s were not the 8-yard, knife pleated kilts with which we are so familiar today. Rather, they were made from about four yards of tartan and pleated in box pleats that were typically quite wide. The photos at right show a traditional box pleated kilt in the Scottish Odyssey tartan. Although box pleated kilts were the norm for most of the 19th century, they passed from fashion when knife pleated kilts with eight yards of tartan and 25 or more narrow pleats became fashionable toward the end of the 1800s. Traditional box pleated kilts should not be confused with the narrowly pleated, military box pleated kilt, which appeared in the late 19th century.

In 1982, Bob Martin resurrected the traditional 4-yard box pleated kilt and has taught the art to a few people, including Matt Newsome. Since then, Matt has made hundreds of traditional box pleated kilts.

Because much of the construction of a traditional box pleated kilt is the same as that of a traditional knife pleated kilt, we thought that a good way to provide instructions for making a traditional box pleated kilt would be to write a supplement to the book *The Art of Kiltmaking* by Barbara Tewksbury and Elsie Stuehmeyer.

These instructions are supplementary to the book *The Art of Kiltmaking*. Where instructions for making a 4-yard box pleated kilt are identical to those for making a traditional knife pleated kilt, the instructions in this supplement refer to specific pages in *The Art of Kiltmaking*. If you don't have a copy of *The Art of Kiltmaking*, you can purchase a copy at

<http://www.celticdragonpress.com>

Happy kiltmaking!

Barb Tewksbury and Matt Newsome



Please note! This document is formatted for double-sided printing. Consequently, some sections have a blank ending page in order for the next chapter to begin on an odd-numbered page.

Chapter I

About traditional box pleated kilts

In this introductory chapter, Matt Newsome shares his knowledge about the history of early kilts, how box pleated kilts were resurrected in the 1980s by kilt historian Bob Martin, and a bit about his experience in making and wearing box pleated kilts.

When most people think of the kilt, they have in mind the many-pleated garment worn by pipers, dancers, and other participants at Highland Games. The kilt is recognized as a traditional garment, and many people assume that the Scottish kilt has remained fairly constant in style over the ages. However, the kilt is not merely a folk costume, mimicking the style of a particular era, but is in fact a contemporary national dress. Though steeped in tradition, Highland fashion is a fashion nonetheless, and like other fashions, it has changed over time. We should not be surprised to discover, then, that the kilt has undergone stylistic change over the ages.

The Art of Kiltmaking goes into great detail describing how to make the typical kilt of today – a garment containing eight linear yards of fabric, pleated either to stripe or to sett, with a large number of knife (side) pleats in the rear. This present supplement to that text details the construction of a different style of kilt, one made using only four linear yards of cloth and box pleated. It is important to understand the place of these various kilt styles in the still-evolving history of Highland clothing.

Early untailed kilts

The earliest form of the kilt for which we have any documentation is the belted plaid, called in Gaelic the *feilidh-mór* or “great wrap.” This garment, datable to the end of the 16th century, was essentially a large, untailed length of cloth that was gathered at the waist and belted around the body. Its construction consisted of two lengths of single-width cloth (some 25-30” wide) sewn together lengthwise to create a width sufficient to reach from the knees to above the shoulders. The length of cloth used likely varied from kilt to kilt, but the average seems to have been about four yards (or eight yards total of single-width fabric). Extant military records of the 18th century indicate that some may have been as little as three and a quarter yards in length. Five or six yards seems to have been the maximum.

The next stage in the kilt’s evolution was the *feilidh-beag* or “small wrap,” often Anglicized to “phil-labeg.” The precise origin of this form of the kilt is debated, but it was in use during the early 18th century. It was essentially the lower half of the old belted plaid. Still an untailed garment, it consisted of a single-width length of cloth that was gathered into folds and worn belted about the waist, the bottom reaching the knee, with the top extending a few inches above the belt. A separate plaid could be worn about the shoulders and removed when not required. This garment was also about four yards in length on average. *The Statistical Account of Scotland* from 1793 states that “the wages allowed to a man who can plow, sow, etc., is £6 sterling, together with shoes and clothes: he is allowed four pair of single shoes, commonly called Brogues, two pair of hose, four yards of tartan for a Phellibeg, and a short coat and vest of some coarse kind of cloth.” Thus was the average Highland male outfitted at the end of the 18th century.

The *feilidh-mór*, as a large length of untailed cloth, served as a blanket as well as for clothing. The word *plaid*, in fact, means “blanket.” With the reduced width of the *feilidh-beag*, its usefulness as a blanket was limited. Little benefit was gained by leaving the kilt as an untailed garment that had to be arranged at each and every wearing. A more practical style was needed, and by the end of the 18th century, tailors began to sew the pleats in place permanently from waist-to-hip. Thus the first true tailored kilt was born. Because the *feilidh-beag* that it descends from was about four yards in length, we should not be surprised that the earliest tailored kilts were also four yards long.

The evolution of box pleated kilts

The oldest surviving tailored kilt that we know of is a military kilt dating to 1796 from the Gordon Highland Regiment. It contains exactly three yards, two inches of cloth, and is box pleated. This kilt is

25" in length, being made selvedge-to-selvedge, using the entire uncut width of the fabric. The pleats are sewn both inside and out, with no tapering at all. There is no lining, no straps or buckles, and both apron edges are self-fringed. This kilt is fully documented in *All About Your Kilt*, by Bob Martin (revised edition, 2001).¹

Martin's book is an invaluable reference for documenting the changing kilt styles of the past 200 years. The kilts he documents give a very good indication of what the typical kilt of the late 18th and early 19th century was like. These include:

- An early 19th century Cameron of Erracht kilt, box pleated and made from three yards, six inches of cloth.²
- A pre-1800 Seaforth Highlanders kilt (MacKenzie tartan), box pleated and made from three yards and 29" of cloth.³
- A Spens tartan kilt, c. 1800, made from four yards, four inches of cloth, with 15 box pleats.⁴
- A mid-19th century Forbes tartan kilt with eight box pleats, made from three yards and 29" of cloth.⁵

Most of the kilts documented in *All About Your Kilt* are from collections in the UK. In America, the Scottish Tartans Museum in Franklin, NC has two early



Box-pleated MacDuff kilt, c. 1800 (collection of the Scottish Tartans Museum, Franklin, NC).

box pleated kilts. One is a MacDuff kilt, c. 1800, made from four yards of cloth (photos above). This kilt has only six very wide box pleats. The second is in the Lochiel tartan, c. 1800-1820, and made with twelve box pleats.

From the evidence available, we can say with confidence that the original style of tailored kilt was box pleated and made from approximately four yards of cloth. All of the early military kilts were pleated to the stripe. Civilian kilts were originally pleated to nothing, that is, to no pattern at all, neither to stripe nor to sett. The pleats were laid out irrespective of the pattern of the tartan. Both of the early 4-yard kilts on display in the Scottish Tartans Museum are pleated to nothing. From approximately 1815 on, however, civilian kilts tended to mimic the military fashion and were also pleated to the stripe. This soon became the most common style.

As an aside, pleating to the sett was unheard of until the end of the 19th century. In 1901, Stuart Ruardhi Erskine wrote of this style of pleating in *The Kilt and How to Wear It* as a new and novel fashion. He writes, "This pleat is comparatively rarely practiced; but I am pleased to observe that it is becoming more popular; for though it may not have age and precedent to recommend it... yet, when properly made, it is undoubtedly more becoming than the other."⁶

The standard style, therefore, of kilt for both military and civilian wear for the first half of the 19th century



19th century painting of a box pleated kilt (Robert MacLan, c. 1845)⁷



19th century painting of a box pleated kilt (Robert MacIain, c. 1845)

was a kilt made from four yards of cloth, box pleated to the stripe, as shown in the 19th century illustrations at left and above.⁷ It is practical, comfortable, and balanced – well suited to those for whom the kilt was the average daily mode of dress.

The evolution of knife pleated kilts

The first Highland regiment to shift to the knife pleated kilt was the Gordon Highlanders in 1854. Others soon followed, and -- as is often the case with Highland attire -- civilian style soon copied the military example. The use of knife, or side, pleats made it much easier to include additional yardage in the kilt. The second drawing at right shows how knife pleats differ from box pleats, which are shown in the first drawing at right.

The more fabric used in the kilt, the more pleats a kilt can have; the pleats will be deeper and the visible portion of the pleat smaller. This, combined with the increased “swish factor” with the higher yardage, makes the 8-yard kilt a much “fancier” garment, if you’ll forgive my use of that term.

The ideal box pleat has little or no overlap where the pleats meet on the inside. For most gentlemen,

anything more than four yards in a box pleated kilt would result in considerable overlap. With a knife pleated kilt, overlap in the pleats is expected and easily accommodated. Thus the kilt maker can make the kilt with five, six, seven and even eight yards of tartan for an average sized wearer.

In fact, a box pleated kilt, just as a knife pleated kilt, *can* be made from much more than four yards. Additional cloth in a box pleated kilt results in a substantial amount of overlap on the inside of the pleats. The kilt will have more pleats, and the visible face of each pleat will be narrower, meaning that one side of the box pleat will be very narrow, while the other side is very deep, to accommodate the extra material (the third drawing below). To the casual observer, the effect looks very much like a typical knife pleated kilt. This is, in fact, the origin of so-called “military box pleating” used in kilts worn by regiments such as the Seaforth and Cameron Highlanders.

Because the formal tailoring of the kilt was still relatively new, the 19th century saw much experimentation and variation in pleating styles. This includes kilts that incorporated both box and knife pleats, such as the Kingussie style of pleating (fourth drawing below), which is named for a kilt made in this

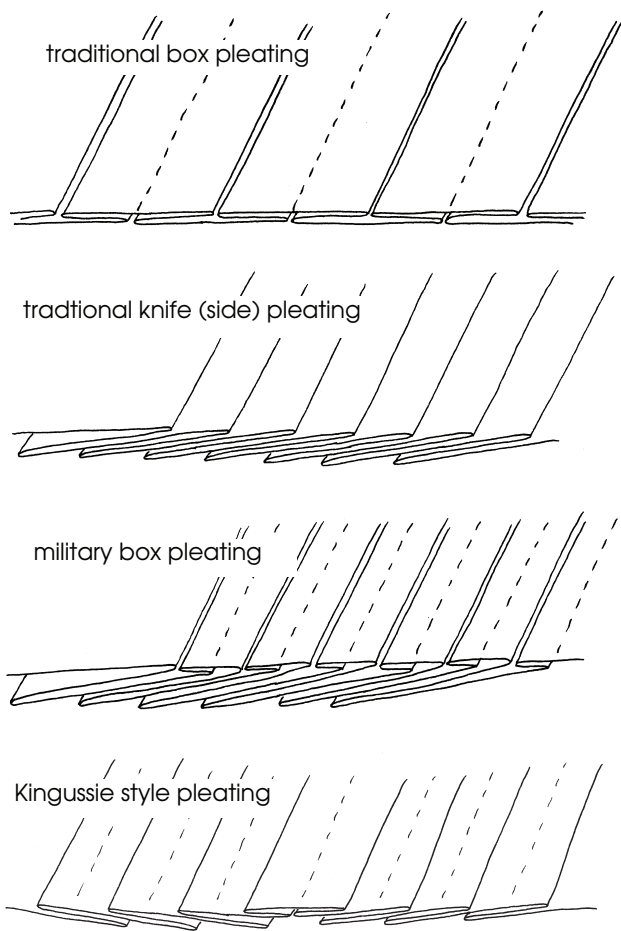

style and housed in the Highland Folk Museum in Kingussie, Scotland. The kilt makes use of a single box pleat in the center back, with knife pleats running in opposing directions on each side.

The move towards more material in a kilt corresponded with the gradual shift away from the kilt as a daily-wear garment. By the end of the 19th century, the kilt was used primarily for ceremonial dress. When a mode of dress becomes ceremonial, it also tends to become more stylized, which is exactly what we see happening with Highland dress. No one ever dreamed of writing a "how to wear the kilt" manual of Highland clothing in the 18th century! But in the 20th century, such instructions (often contradictory) abound. The kilt has become ceremonial for many who wear it.

The revival of box pleated kilts

The modern revival of the original tailored kilt is the result of much research and effort on the part of Bob Martin, kilt maker and kilt historian. Martin, an American of Scottish descent, currently resides in North Carolina but spent most of his kilt making career in and around Greenville, SC. A Fellow of the Scottish Tartans Society, he engaged in much original research into the history of the kilt, making frequent trips to Scotland and getting to know museum curators, tartan researchers, and those in the tartan industry.

It was around 1982, when speaking with Scottish anthropologist Dr. Micheil MacDonald (author of the popular *Scots Kith and Kin* and father of tartan hand weaver Peter MacDonald), that Bob wondered how he could convince residents of the comparatively warm American South that heavy weight wool was the best material for kilts. Dr. MacDonald suggested that, if people wanted a cooler and more comfortable kilt to wear, Martin should offer a traditional 4-yard box pleated kilt. This style could be made from superior heavy weight kilting cloth, yet still be lighter than an 8-yard kilt made from much lighter weight material.

Martin soon thereafter added this traditional style of kilt to his kilt making business, with much success. One still sees many 4-yard box pleated kilts made by Bob Martin (typically from cloth woven by Peter MacDonald) at the Greater Greenville Highland Games in South Carolina. When he retired from active kilt making in 1998, Martin turned his business over to Wanda and Kerry McSwain of Columbus, NC, whom he trained to make all styles of kilts, including box pleated kilts.

The McSwains are not the only kilt makers today who offer the traditional 4-yard box pleated kilt. Bob Martin has generously shared his knowledge,

teaching many others, including the author, how to make this style of kilt. At the time of this writing at the end of 2008, I have made over 300 box pleated kilts. Through my writing, online posting, and my work at the Scottish Tartans Museum, I have attempted to promote the 4-yard box pleated kilt, not as superior to the 8-yard kilt, but as an equally viable option for today's kilt wearer. I have been wonderfully surprised by the increased popularity in this style over the past few years. Everything old is new again!

The benefits of a box pleated kilt

There has been a recent trend back towards the kilt as a functional everyday garment, and for that, the 4-yard box pleated kilt has much to recommend it. It is more economical -- using half the material of a typical modern kilt saves on cost. It is more comfortable for daily wear. And, unlike modern "contemporary" styles of kilt-like garments for men, such as the American Utilikilt and its many imitators, the 4-yard box pleated kilt is rooted firmly and unquestionably in the Scottish tradition.

This is not meant to suggest that the 4-yard kilt is suitable for casual daily wear only. Wear it with a formal doublet, diced hose and a fancy sporran, and you will be just as well prepared for a Highland ball as the next man with his 8-yard kilt.

I have been wearing the kilt on a very regular basis for the past 15 years. The form of the that kilt I, as a living historian, originally wore most often was the historical *feilidh-mór*. While it is a wonderful garment for cold, wet outdoor use, its practical use as a 21st century garment is quite limited. The modern tailored kilt, which I have worn on a nearly daily basis for the past ten years, is infinitely more suited to general wear today. Having much experience wearing both 8-yard kilts, and the older 4-yard box pleated style, I can say without reservation that the 4-yard kilt is the more comfortable of the two.

To begin with, it is a very balanced garment. By that, I mean that there is typically slightly less than two yards of fabric in the overlapping front aprons, and slightly more than two yards of fabric pleated in the rear. Compare that with an 8-yard kilt, which also will have something less than two yards in the front aprons but has more than six yards hanging in the rear. Most of the weight is in the back!

Granted, this concentration of weight in the rear contributes greatly to the "swing and swish" of the kilt. The weight acts as a pendulum, and the pleats swing elegantly with each movement of the wearer. This stylistic advantage may very well have been one reason for the move towards more yardage during the 19th century.

The purpose of this document

The instructions you will find in this document are for a modern kilt made in the style of the traditional box pleated kilt of the late 18th and early 19th centuries. This is not a manual for making a replica of an historical kilt. Modern kilts contain many features that were not included in early tailored kilts, such as straps and buckles, lining, and tapering in the pleats from waist to hips. Most of these earliest tailored kilts contained nothing more than a length of tartan cloth and the thread used to sew the pleats. And, being made selvedge-to-selvedge, they did not even have need of a waist band. On the other

hand, some early kilts had features not typical in a modern kilt, such as ribbons used for tying the kilt closed, or buttons for braces (suspenders).

This is illustrative of the fact that the kilt, like all other articles of clothing, is a changing garment. Just as a man's shirt of 1750, or even 1950, will be different in style from shirts of today, while remaining the same in essence, so too the kilt. The modern-day revival of the box pleated kilt means that we are looking back in time for inspiration to when the kilt was the daily garb of the Highland Gael. I can only count this a very good thing!

¹ Martin, Bob, *All About Your Kilt*, Scotpress; Bruceton Mills, WV, 2001. 53.

² *ibid.* 54

³ *ibid.* 59

⁴ *ibid.* 59

⁵ *ibid.* 64

⁶ Erskine, Stuart Ruaidri, *The Kilt & How to Wear It*. 1901. Scotpress; Bruceton Mills, WV, 1999. 44.

⁷ The 19th century illustrations in this chapter were done as paintings by Robert R. Maclan and published in 1845 in *The Clans of the Scottish Highlands*, by James Logan. The paintings have been reproduced in the book *The Clans and Tartans of Scotland* by Crescent Press (1983). We have reproduced them here in accordance with their restrictions.

Chapter 4 Supplement

Understanding box pleated kilts

We hope that you'll take a little time to understand box pleated kilts before you embark on making your kilt. In this chapter, we'll help you understand how the tartan you've chosen and the size of the person you're making the kilt for influence the number of pleats and the box geometry.

General structure of a box pleated kilt

With the exception of the pleats, the overall structure of a box pleated kilt is the same as the structure of a traditional knife pleated kilt. The kilt diagram below illustrates the difference between a box pleated kilt and a knife pleated kilt (illustrated

on page 34 of *TAoK*). Instead of having all pleats facing in one direction, box pleats are bordered by opposite-facing underfolds with a wide pleat face in between. Because box pleats are 2-3" or even 3½" across, a typical box pleated kilt has only 7-10 pleats across the back, as opposed to 25 or more across the back of a traditional knife pleated kilt.

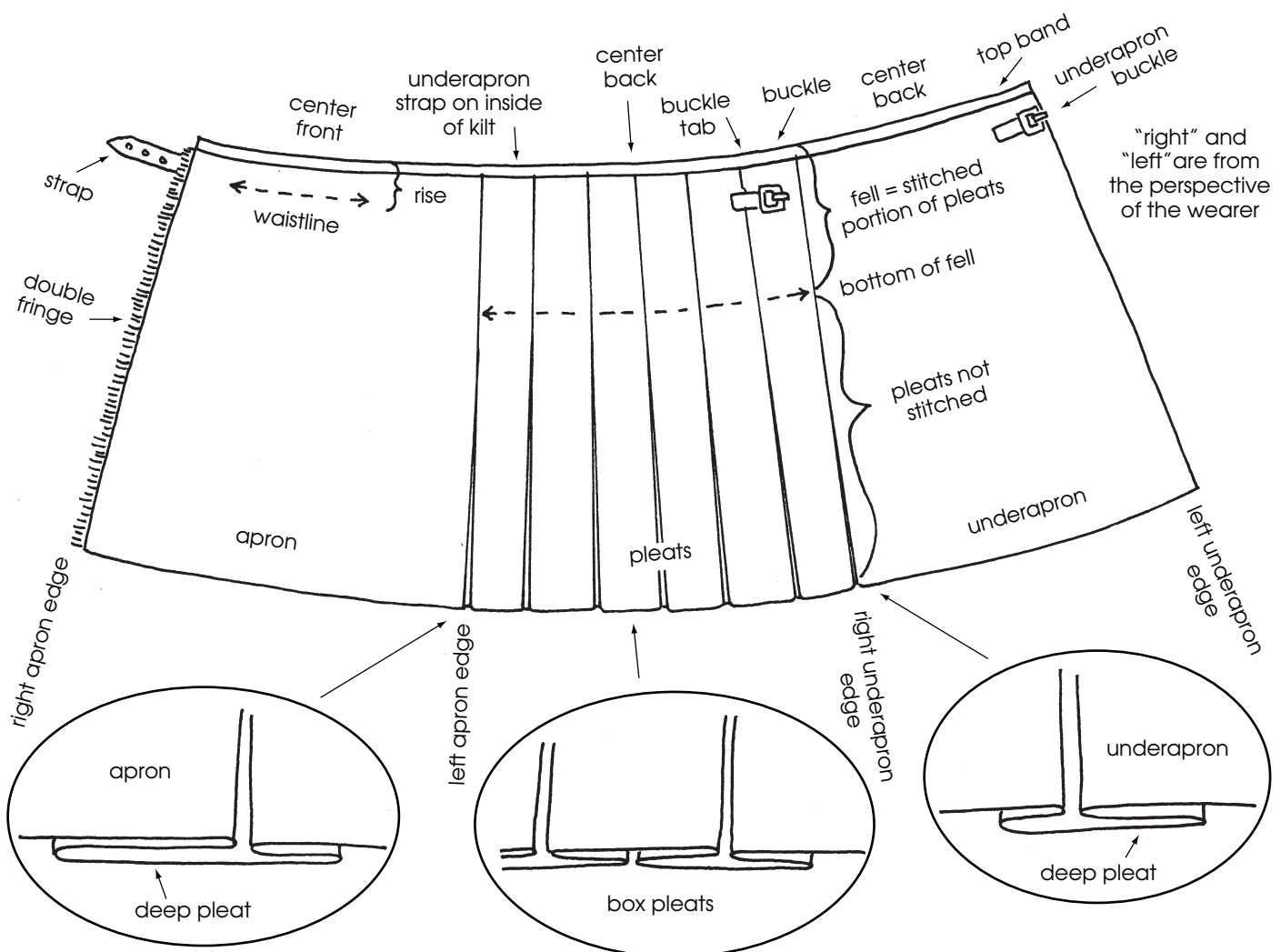

Relationships among sett size, pleat size, and box geometry

The wide face of a box pleat is underlain on each side by an underfold. Ideally, the two underfolds meet directly behind the center of the pleat face, as shown in the top diagram below. In practice, this may not always be possible, as described later in this section, and a small gap (middle diagram) or overlap (bottom) between the edges of the underfolds is acceptable. If the overlap is significant, the kilt becomes a military box pleated kilt (illustrated on page 7).

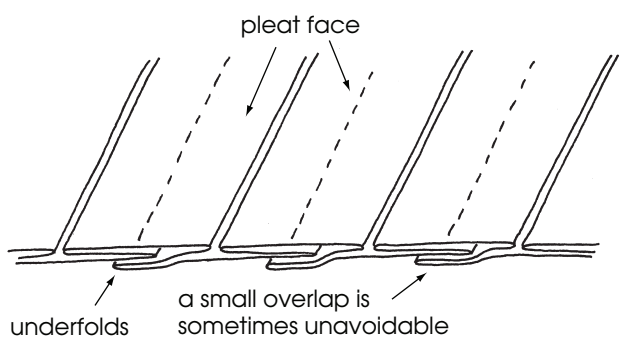
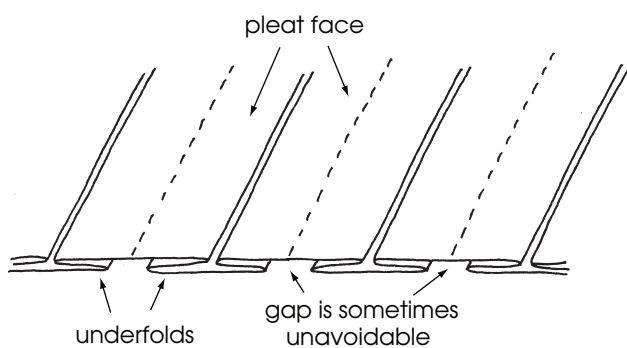
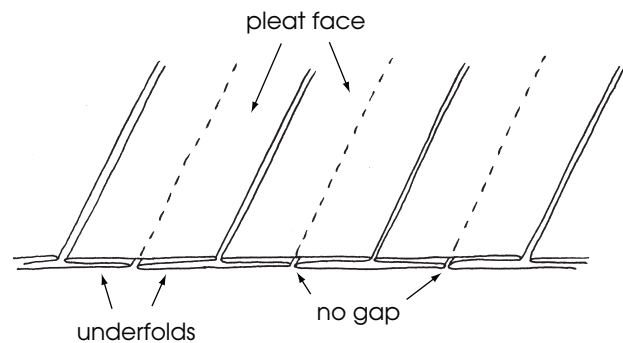

The width of the pleat face is governed by the size of the sett. In the examples that follow, we will look at a kilt pleated to the stripe, which is the most common style of pleating for a box pleated kilt. If the kilt is pleated to the sett, the situation is a bit more complicated, but the same principles apply.

Let's start by looking at a tartan with a sett of 9". One full sett can be measured between any two

black stripes shown in the diagram below. If we want to place the black stripe down the center of each pleat, we would fold the tartan in opposite directions along the dashed lines and bring the two dashed lines together along the dotted lines, forming a box between the two adjacent pleats. If we repeat the process for the next stripe to the right, we'll form a full pleat in the middle. The underfolds meet behind the pleat face.

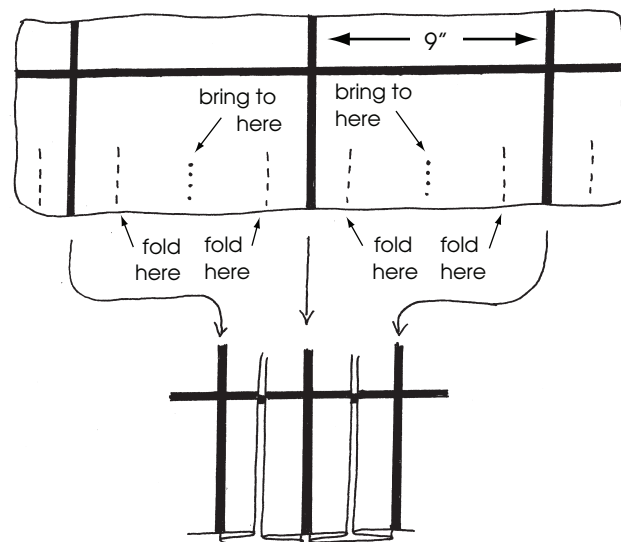

Notice that $\frac{1}{3}$ of the fabric (3" in this case) is in the face of the pleat, with $\frac{1}{3}$ in each underfold on the two sides. The pleat depth of each underfold in this example is $1\frac{1}{2}$ ".

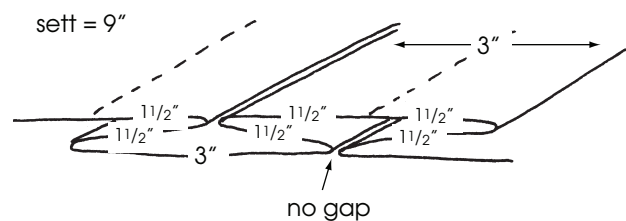

The general rule of thumb for box pleats is that pleat width is $\frac{1}{3}$ of the pleat repeat. If you are pleating to the stripe, the pleat repeat is equal to the sett size.

What happens if the sett size is smaller? Let's look at a tartan with a sett size of $7\frac{1}{2}$ ". The pleat width will be $\frac{1}{3}$ of the sett size, or $2\frac{1}{2}$ ", as shown below. If the pleat width is $2\frac{1}{2}$ ", there won't be any gaps between the underfolds.

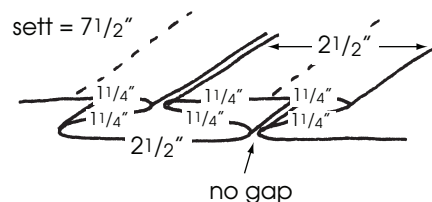

What would happen if you wanted to make the pleat width 3", instead of 2 1/2"? As shown below, the pleat face would be 3", but that would leave only 4 1/2" to split between the two underfolds. Each underfold will have a pleat depth of 1 1/8", leaving a gap behind the pleat face of 3/4".

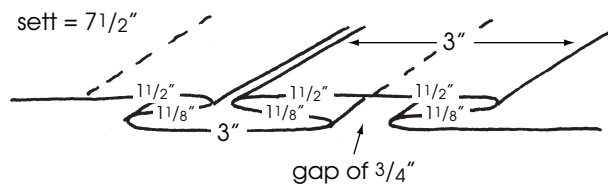

In order to minimize the gap between the underfolds behind the pleat face, pleat width must decrease as sett size (pleat spacing) decreases. So, the size of the pleats is not a matter of choice but is largely dictated by the size of the sett.

In practice, it is common to have a small gap or overlap between the edges of the underfolds. Suppose you had a kilt that needed to be 22" across the

pleats at the hips. The number of pleats that you can put into the back of this kilt is simply 22" divided by the pleat size. Suppose that your tartan had a sett size of 6 3/4". In order to have no gap behind the pleat face, the pleats would each have to be 2 1/4" wide (1/3 of 6 3/4"). Dividing 22 by the pleat size gives 9.8 pleats. Because you can't have a fraction of a pleat, you could either:

- round down to 9 pleats and make the pleats each 2 7/16" across, instead of 2 1/4". That would leave a gap of a bit more than 1/4" behind the pleat face, which is acceptable.
- round up to 10 pleats (if you have enough tartan), and make each pleat a bit more than 2 3/16" across, instead of 2 1/4". That would leave an overlap of less than 1/4" behind the pleat face, which is acceptable.
- increase the planned width across the pleats to 22 1/2", make 10 pleats, and decrease the planned width across the apron by 1/2".

Chapter 5 Supplement

Preparing to make a box pleated kilt

In this chapter, we'll outline what you need to make a box pleated kilt. You will find additional information on tartan and suppliers in *The Art of Kiltmaking*.

List of materials

4 to 5 yards of wool tartan, preferably 16 oz. (see this chapter and *TAoK* Chapter 3)
 $\frac{3}{4}$ yard to 1 yard of hair canvas (*e.g.*, Tailor's Pride®) (see tips and hints *TAoK* page 94)
1 yard cotton lining material (see tips & hints *TAoK* page 109)
thread (see tips & hints *TAoK* page 73)
 1 spool 100% polyester white basting thread
 high quality 100% polyester thread in colors matching the tartan
 1 spool carpet (button/craft) thread (use white if you will use white lining fabric)
2 silver-colored buckles and black or brown leather straps (see tips & hints *TAoK* page 105)

several short, fine needles
a thimble
tape measure, with inches divided into sixteenths (a quilter's tape measure divided into eighths is *not* adequate)
a chunk of beeswax
a piece of clay tailor's chalk (see tips & hints *TAoK* page 52)
several common pins
an iron, pressing ham, pressing cloth (an old pillow case works fine), and spray bottle

Selecting tartan

Varieties of tartan suitable for kiltmaking are well-described in Chapters 3 and 5 of *TAoK*. All we will say here is that box pleated kilts look best when made from heavy weight tartan. 16 oz. tartan is ideal, as is 18-20 oz regimental weight tartan. Medium weight (13-14 oz.) tartan will work, but it is on the light side for a box pleated kilt. Choose a 16 oz tartan if at all possible, although you may not have a choice if the tartan you want to use is available only in 13-14 oz.

Anything lighter than 13-14 oz. tartan is unsuitable, because it doesn't have enough weight and stiffness to keep the pleats hanging smoothly, and the kilt

winds up being a bit "flippy" and looking too skirt-like. If you choose a light weight tartan, you will be disappointed with your box pleated kilt.

How much tartan will I need?

A box pleated kilt for a person with hips less than 44" requires 4 linear yards of tartan. Most tartan today comes in double width (54-60" wide), and 2 yards of double width tartan can be split to provide the 4 linear yards needed for a kilt. For a hip measurement more than 44", get 2.5 yards of double width tartan. For hips larger than 56", get 3 yards. If you want enough tartan to make a set of flashes, get an extra $\frac{1}{4}$ yard.

****Warning about asymmetric tartan****

The warning on page 45 of *TAoK* about the difficulties associated with asymmetric tartan also applies to box pleated kilts. Be sure to read this section and heed the warnings. Tartan asymmetry is defined and described in Chapter 3 of *TAoK*.

Taking a person's measurements

Follow the instructions on page 45-46 of *TAoK* for taking a person's measurements.



Laying out a box pleated kilt & marking the tartan

Instructions for the main part of kilt construction begin here. By the end of this chapter, you will have planned the shaping and pleating for your kilt and marked the tartan to get it ready for sewing. Be sure that you have a record sheet prepared for your kilt. You will refer to it often!

Understanding shaping and splitting the waist & hip measurements

Read about shaping a kilt, and follow the instructions on pages 49-54 of *TAoK* for splitting the waist and hip measurements, marking the kilt length, and ripping the tartan to length.

Choosing between pleating to the sett and pleating to the stripe

The general differences between pleating to the sett and pleating to the stripe are described on page 57 of *TAoK*. Most box pleated kilts are pleated to the stripe. Pleating to the stripe commonly produces a kilt that is different in color front and back, with pleats that open up to show a contrasting color, as shown at right in the Scottish Odyssey tartan.



Deciding how to pleat your kilt

Pleats in a box pleated kilt look best when they are 2-3" across. Pleats a bit more than 3" across are OK, but you don't want them less than 2" across. As described in the section on understanding the structure of a box pleated kilt (page 11), the ideal pleat width is $\frac{1}{3}$ of the sett, with $\frac{1}{3}$ of the sett in the pleat reveal and $\frac{1}{3}$ taken up on each side in the underfolds that meet at the center of the back of the pleat. The general rules for determining how to pleat your kilt are described below and are illustrated in the chart and table on pages 18-19). Sett sizes below are listed with the most common sett sizes first.

- **If your tartan has a sett size of 6-9"** (by far the most common sett size), having one pleat every sett gives a pleat size of 2-3" ($\frac{1}{3}$ of the sett). This kilt will be pleated to the stripe.
- **If your tartan has a sett size between 4.5 and 6"**, pleating to the stripe will give pleats that are too small (1.5-2"), if placed every sett, and too big (3-4"), if placed every two setts (although 3-4" pleats may be a good option for men of girth). The solution is to place the



pleats every 1.5 setts. Pleat size in this case is determined by multiplying the sett size by 1.5 and dividing by 3 (e.g., 5" sett X 1.5 = 7.5", which gives as pleat size of $\frac{7.5}{3}$ or

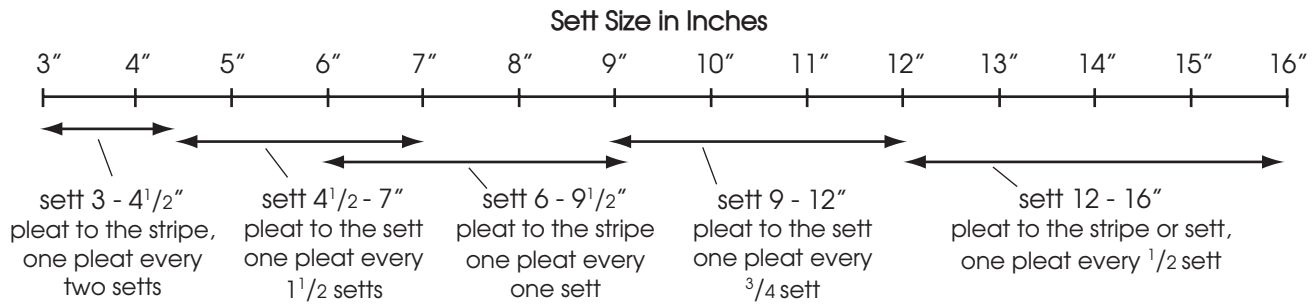

2.5"). Choosing a pleat every 1.5 setts means that alternate pleats will be different and will approximate the sett across the pleats.

- **If your tartan has a sett size between 9 and 12"**, having one pleat every $\frac{3}{4}$ sett will give pleats 2-3" across. The pleats will repeat some of the elements of the sett, and every 4th pleat will be the same.
- **If your tartan has a very large sett** (e.g., 12-18"), having one pleat every half sett gives a pleat size of 2-3". If the tartan is an ABAC tartan (see Chapter 3 of *T AoK*), you can pleat to the A block and have a kilt pleated to the stripe (e.g., the Hunting Robertson and Weathered Stewart Old Sett on page 19). If you pleat to the B and C blocks, or if your tartan is an ABCD tartan, the kilt will be pleated to the sett, rather than to the stripe.
- **If your tartan has a very small sett** (3-4.5"), having one pleat every two setts gives 2-3" across. This kilt will be pleated to the stripe.

The bullets above provide general guidelines, and there is some flexibility at the lower and upper limits of the sett size ranges shown above. Many tartans have sett sizes between 6 and 7 inches. In this range, both pleating to the stripe (one pleat every sett) and pleating to the sett (one pleat every 1.5 setts) works.

- If you want larger pleats, choose pleating to the sett.
- If you want smaller pleats, choose pleating to the stripe.

At right, you'll see the U.S. Army tartan (with a sett of 6 $\frac{3}{8}$ ") pleated to the stripe and to the sett. Pleating to the stripe gives pleats 2 $\frac{1}{8}$ " across (middle right), whereas pleating every 1.5 setts gives pleats 3 $\frac{3}{16}$ " across (bottom right).

The chart at the top of this page summarizes the options, and the options are illustrated on page 19.

As an aside, early 19th century civilian box pleated kilts were pleated to no pattern at all. If you have a very complex tartan, pleating to "nothing" might be a good, and very traditional, option.





↑ 4" ↑

PSD (Private Security Detail) tartan

- very small sett
- should be pleated to the stripe, with one pleat every other sett (e.g., one pleat every other red stripe).
- pleats will be about $2\frac{5}{8}$ " wide ($\frac{1}{3}$ of 8").



↑ 6" ↑

Dress Blue Thompson tartan

- small sett
- could be pleated to the stripe, with pleats about 2" wide ($\frac{1}{3}$ of 6")
- could also be pleated to the sett, with one pleat every $1\frac{1}{2}$ setts; pleats would be about 3" wide ($\frac{1}{3}$ of 9").
- If pleated to the sett, pleats would alternate between the red stripe and the yellow stripe.



↑ $7\frac{7}{8}$ " ↑

Ancient Pride of Scotland tartan

- medium sett
- should be pleated to the stripe (e.g., either the white or the wide green stripe).
- pleats would be about $2\frac{3}{8}$ " wide ($\frac{1}{3}$ of $7\frac{7}{8}$ ").



↑ 13" ↑

Modern Hunting Robertson tartan

- this large sett needs two pleats per sett.
- could be pleated to the stripe by choosing the red stripe, which occurs twice per sett.
- could also be pleated to the sett alternating the white stripe with the wide blue stripe.
- in both cases, pleats would be about $2\frac{3}{16}$ " across ($\frac{1}{3}$ of half of the sett, or 6.5").



↑ $14\frac{1}{4}$ " ↑

Weathered Stewart Old Sett tartan

- this large sett needs two pleats per sett.
- could be pleated to the stripe by choosing the narrow red stripe, which occurs twice per sett.
- could also be pleated to the sett by alternating the grey and tan stripes or blocks.
- in both cases, pleats would be about $2\frac{3}{8}$ " across ($\frac{1}{3}$ of half the sett, or $7\frac{1}{8}$ ").

Which stripe to choose

The choice of stripe to pleat to has a profound influence on the appearance of the back of the kilt. Below, you'll see two dramatically different versions of pleating for the New Hampshire tartan.



The two versions of pleating for the Antarctica tartan shown at right illustrate that some choices (e.g., the whiter version, middle) are dominated by horizontal elements and others are more balanced (bottom version). Other tartans have choices that are dominated by vertical elements (e.g., the U.S. Army tartan pleated to the yellow stripe on page 18). For the Antarctica tartan, the bottom choice at right avoids the dreaded "lawn chair effect" of the choice in the middle.

Marking the apron and pleats

- 1 Decide whether you will pleat to the stripe (one pleat every sett or every two setts) or to the sett (every 1.5 setts or .75 setts). Measure the pleat repeat in inches.
- 2 Divide the pleat repeat by 3 to get the pleat size at hips (e.g., $7.5'' / 3 = 2.5''$).
- 3 Go to your record sheet, and find the split that you chose for the hip measurement in the pleats. Divide the hip split in the pleats by the pleat size determined above (e.g., $23'' / 2.5'' = 9.2$). Round to the nearest whole number (e.g., 9 or 10). This is the number of pleats that you will have.
 - If you round down, your pleats will be slightly larger than the ideal size (in this example,



slightly more than 2½" each) and will not quite meet in the back of the pleat. This is OK. You will figure out the exact pleat size later in this section.

- If you round up, your pleats will be slightly smaller than the ideal size (in this example, slightly less than 2½" each) and will overlap slightly in the back of the pleat. This is OK. You will figure out the exact pleat size later in this section.
- If you want the underfolds to meet in the back of the pleat, multiply your pleat size by the number of pleats (e.g., 2.5" x 9 = 22.5") and adjust the apron measurement in the hips to compensate (in this example, by decreasing the apron hip measurement by ½").

4 If you are pleating to the stripe, decide which stripe you will pleat to.

The kilt you are making has a small amount of yardage, and you'll need every inch that you have. In order to avoid having to mark and re-mark, you will do a test layout for both the pleats and the apron before committing to either.

- 1 Start by reading pages 55-56 in *TAoK* to see how the apron for a knife-pleated kilt is laid out. Your apron will look exactly the same, but we won't actually chalk the outline until we're sure where the pleats will be. The diagram at the bottom of the page shows how you will do a test layout.
- 2 Lay one piece of your tartan out so that the ripped edge is toward you and the selvedge edge is away from you. Make sure that the twill line slants away from you to the left.
- 3 Go to the center back of your tartan (the left hand end of one of your pieces, if you have two ripped pieces, or the middle of the piece, if you have a single piece). Put a pin in at the closest pleat stripe to the end of the tartan. If the stripe is closer than 2 ½" to the end, skip that stripe and choose the next one to the right. Mark each pleat

back toward the apron end of the piece. If you are pleating to the stripe, put pins in at identical stripes. If you are pleating to the sett, put pins in at alternating stripes every 1.5 setts or .75 setts.

- 4 If you have an odd number of pleats, put pins in for half of your pleats plus one (e.g., if you have nine pleats total, mark 5 pleats on this half of the tartan). If you have an even number of pleats, mark half of your pleats on this piece of tartan.
- 5 From your last pin, measure over ½ your pleat repeat, and put in one more pin. Then, measure over 9", and put in one last pin. Put a pin in at this same position on the selvedge edge. This pin marks the left edge of the apron.
- 6 Go to your record sheet, and find the split that you chose for the hip measurement in the apron. Divide the hip split in the apron in half, and add 1.5" (e.g., 22"/2 = 11" + 1.5" = 12.5"). Choose a center stripe for the apron that is approximately this distance to the right of your last pin at the selvedge.
- 7 Measure half the hip split in the apron plus 1.5" from this center front stripe toward the end of the tartan, and put a pin at the selvedge. This pin should be at least 5-6" from the raw end of the fabric.
- 8 OK. So that's the test. If you had enough room for your apron and all your pleats, and you're happy with where the apron will be on the tartan, follow the instructions on pages 55 and 56 in *TAoK* and lay out the apron using your split measurements. Then use tailor's chalk to mark the center of each pleat at the waistline. Count again to make sure that you have laid out the right number of pleats.

If, on the other hand, you came up short, you'll need to make some adjustments before chalking everything.

- You can cut down the 9" from step 5 above to 7", although this makes the pleat under the

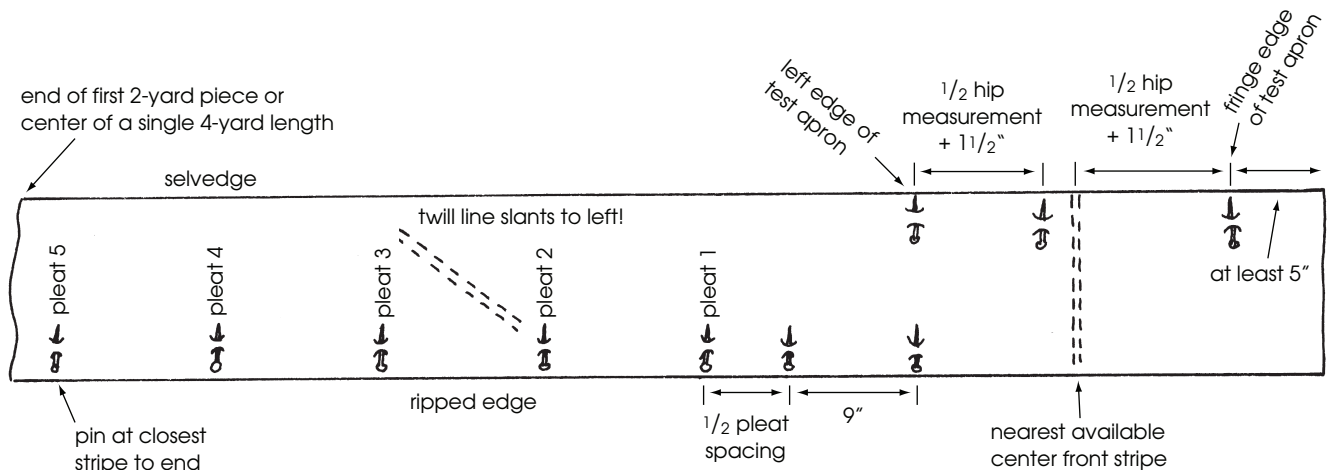

edge of the apron shallower and doesn't allow as much ease for walking and sitting.

- You can also make the apron edge facing smaller by decreasing the 5-6" from step 7 above to 3-4". While that's pretty skimpy, it might be better than taking out pleats.
- For either of the above solutions, remember that you'll still need to center a stripe in the center of the apron.
- Alternatively, you can take out a pleat. If you do this, the pleats will not meet on the inside of the kilt, because each pleat will be larger than $\frac{1}{3}$ of the pleat repeat. This isn't terrible (see pages 12-13), and you might decide that it's the best alternative. Removing one 2.5" pleat from 9 pleats will give you a gap of about $\frac{1}{2}$ " between pleats on the inside of the kilt (although, of course, the pleats will meet on the outside of the kilt!!).

If, instead of coming up short, you have extra fabric after doing your test layout, you can always add a hidden pleat, as described in Appendix C of *TAoK*. Just choose a new center front for the apron, and move the whole apron toward the end of the piece of tartan.

Marking the rest of the pleats plus the underapron

- 1 Lay out the second piece of tartan (or slide your single piece to the right until you're at the middle of piece). Be sure that the ripped edge is toward you and the selvedge edge is away from you, and be sure that the twill line slants away from you to the left. The diagram at the bottom of the page shows how you will lay out your test underapron.
 - If you are working with two pieces of tartan, start one full tartan repeat from the right hand edge in order to leave enough tartan to make

the join. Mark the remaining pleats with chalk. Double-check that you have marked the correct number of pleats total on your two pieces of tartan.

- If you are working with only one piece of tartan, mark the remaining pleats to the left of the ones you've already marked with chalk. Double-check that you have marked the correct number of pleats total.
- 4 Measure over half your pleat repeat to the left of your last pleat marking, and put in another pin. Measure 8" to the left, and put in another pin. Put a pin in at this same position on the selvedge edge. This pin marks the approximate location of the right hand edge of the underapron.
 - 5 Go to your record sheet, and find the split that you chose for the hip measurement in the apron. Divide the hip split in the apron in half, and add 1.5" (e.g., $22''/2 = 11'' + 1.5'' = 12.5''$). Choose a center stripe for the apron that is approximately this distance to the left of your last pin at the selvedge.
 - 6 Measure half the hip split in the apron plus 1.5" from this center stripe toward the end of the tartan at the left, and put in one last pin at the selvedge. This pin should be at least 5" from the raw end of the fabric.
 - 7 Again, this is a test. If the apron is too close to the raw edge on the left, you can move the apron to the right a bit. Although the underapron should technically be centered on a tartan pivot, in a kilt with as little yardage as this one, it's OK to have it off center – no one is ever going to notice (not true for the apron!!!). Just don't cut the 8" in step 4 above down to less than 5".
 - 8 Once you're happy with the layout, chalk the apron markings as described on page 64 of *TAoK*.

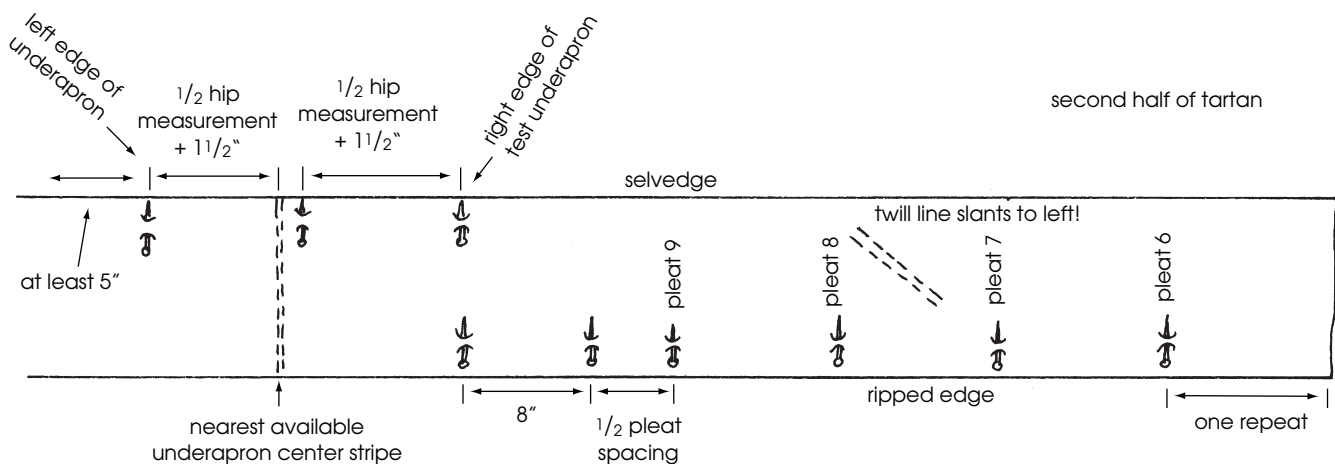

Chapter 8 Supplement

Preparing to sew a box pleated kilt

Now that you have marked your tartan and determined the number of pleats, you need to determine how big each pleat will be before you can start sewing your kilt.

Determining the size of the pleats

Chapter 8 of *TAoK* describes in detail how to calculate the size of your pleats at the hips and at the waist. If you choose to follow these traditional instructions, remember that your number of pleats will be much smaller (7-10 or so) and each pleat will be much bigger (2-3" or more).

Alternatively, you can simply divide the hip split in the pleats by the number of pleats and round to the nearest $\frac{1}{32}$ " (e.g., 22" and 9 pleats will be 2.44"/pleat, or $2\frac{7}{16}$ "). Repeat for the apron split in the pleats.

Making a record sheet

Make a record sheet as described on page 69 of *TAoK*, and attach it to the apron of your kilt. You're ready to sew!!

Chapter 9 Supplement

Sewing a box pleated kilt

Well, here goes! You're finally ready to start sewing your kilt! By the end of this chapter, you will have a finished kilt. So, collect your needle, thread, thimble, scissors, work light, and let's go!

Basting the apron edges

Read the boxes on basting and selecting thread on page 73 of *TAoK*.

Baste the apron edges according to the instructions in *TAoK* starting on page 71 and ending with step 3 on page 72.

Stitching the pleats

The pleats in a box pleated kilt are stitched differently from those in a knife pleated kilt. But the process is not as complicated as you might imagine, because you don't actually need to stitch the box shape into the pleats at the outset. The diagrams below and the photos at right show how the boxes are made. Each pleat is stitched as one big loop. After stitching, the loops are flattened out on the back side into boxes, with one fold each way.

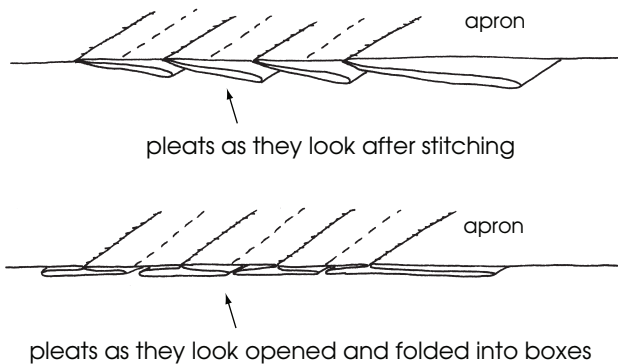

Although you can use a tape measure to locate where to fold and lap the pleats, it's easier to make a pleat gauge (right) from a small piece of card stock, such as a file card. On one edge of the card, measure out the pleat size at the hips and put tick marks at the start, end, and middle of the distance. Label it clearly as "hips". Repeat on a different edge for the waist measurement, and label it clearly. If you want to be sure to have enough flare at the top of the kilt for the top to be comfortable, you can do a third gauge that is $\frac{1}{16} - \frac{1}{8}$ " bigger than the waist for

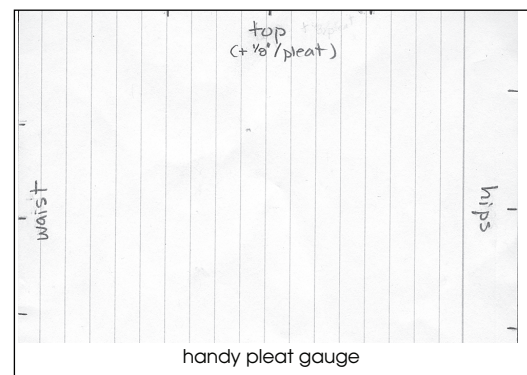

the top edge of the kilt. If you make a third gauge, label it clearly.

You will work with the kilt apron in your lap and the top edge of the kilt toward your left, with the extra tartan in front of you on a table or on the floor.

- 1 Thread a fine needle with enough thread that matches the edge of the apron to stitch the first pleat. Wax and knot the thread. Turn the apron edge over at the bottom of the fell, and stitch two or three stitches through only the back layer to anchor the thread.

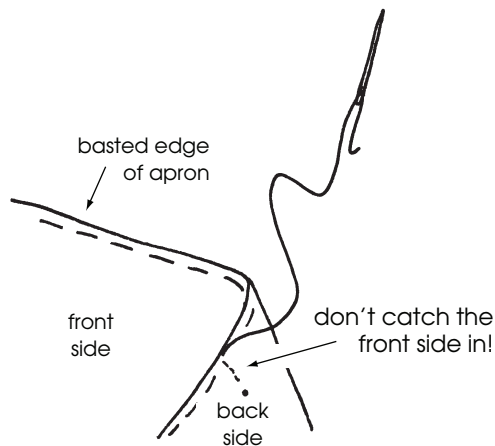

- 2 Locate the first pleat mark on your tartan. Lay the tartan flat on your knee or on the table, making sure that you have only one thickness. Center your gauge on the center stripe of the first pleat at the waist, and lap the apron edge to the pleat edge mark at the waist. Pin the apron edge through one thickness of tartan only, inserting the pin perpendicular to the edge of the apron. Go to the bottom of the fell, rotate your gauge, center it on the pleat stripe, and lap the apron edge to the hip mark on the card.

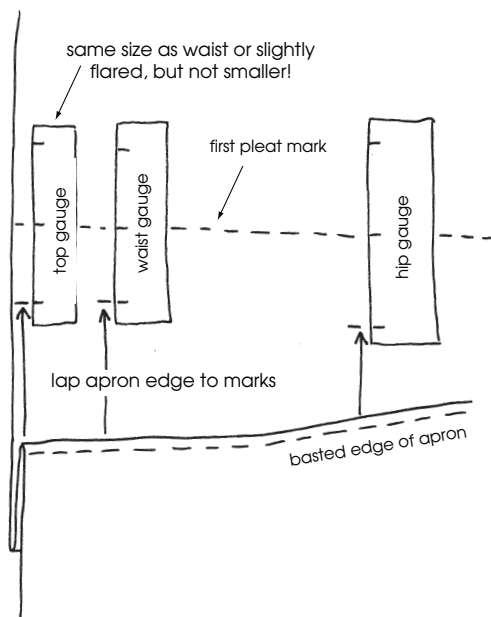

Take two stitches at the edge to anchor the bottom of the pleat. Put the needle in at the bottom of the fell in lieu of a pin. Pull the edge of the apron taut, and pin every couple of inches, inserting pins perpendicular to the edge and matching the stripes. Move to the top of the kilt, rotate your gauge, and pin the edge at the top edge mark on the card.

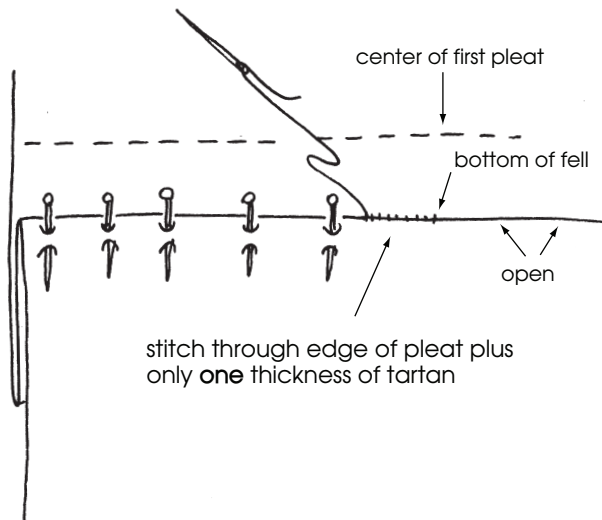

- 3 Before you stitch, read the advice on holding the tartan and pleating accurately in *TAoK* in instructions 5-9 on pages 76 and 77 and on matching stripes on page 79. The assorted pleating advice in the boxes on pages 80 and 81 is also mostly relevant to box pleated kilts as well.

If you have made a knife pleated kilt using *TAoK*, please note that you do **NOT** fold the next pleat before stitching a box pleat. You stitch through only one thickness of tartan in a box pleat.

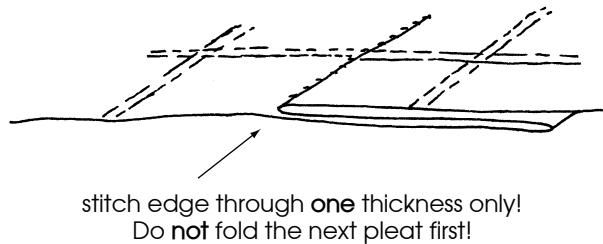

- 4 Stitch the edge of the apron from the bottom of the fell to the top of the kilt, taking care to match stripes and to make the stitches invisible.

Deciding on the strap system for your kilt

Before you stitch the first pleat edge, you will need to decide on the closure system for your kilt. Traditional knife pleated kilts described in *TAoK* have buckles sewn on the outside to the pleats at the



waist, and the underapron strap comes through the pleats in what is called a “buttonhole” (page 34 of *TAoK*). Some box pleated kilts are also made with a buttonhole (as shown in the Leatherneck Tartan kilt above at the top).

Alternatively, you may choose to make your kilt with a buckle on the underapron edge and a strap sewn to the *inside* of the kilt behind where the buttonhole would normally be (as shown in the Dunlop tartan kilt above at the middle and bottom). The kilt “parts diagram” on page 11 of this supplement shows this latter closure. Kilts made for the 79th New York Cameron Highlanders during the U.S. Civil War used this closure method, as shown in a period kilt at the Gettysburg Museum.

Because the buttonhole is formed by a gap in the pleat stitching, pleat size governs whether the buttonhole style of closure is an option for your box pleated kilt.

- If the pleats in your kilt are not more than about 2” across at the waist, you can use the buttonhole style of closure. Of course, you can also use the closure system with the strap inside if you have pleats this size.
- If the pleats in your kilt are much more than 2” across at the waist, you should use the closure system with the strap on the inside. If the pleats are wide at the waist, the buttonhole sits so far back that the underapron strap can’t reach it.

To stitch the first pleat edge

- 1 Center your gauge at the center stripe of the first pleat at the waist; fold the tartan at the pleat edge mark on the card. Put a pin in to hold the fold.
- 2 Go to the bottom of the fell, rotate your gauge, and center the gage at the center stripe of the first pleat at the hips. Fold the tartan at the pleat edge mark on the card. Put a pin in to hold the fold.
- 3 Thread your needle, and wax the thread. Turn the folded edge over at the bottom of the fell, and anchor your thread.
- 4 Fold the first pleat to the right size at the top edge, and pin.

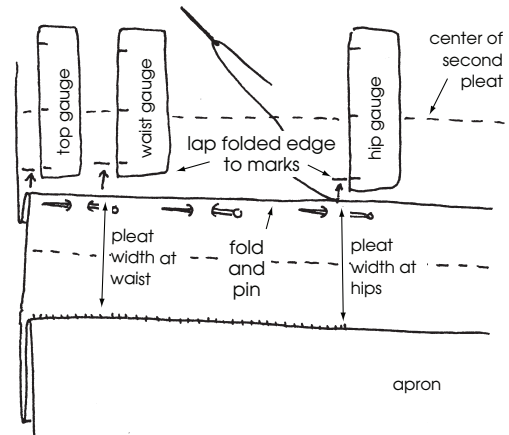

- 5 Lap the pinned edge of the first pleat onto the next section of tartan, and pin the folded edge of the first pleat to one thickness of tartan at the right distance from the center of the second pleat. Put pins in perpendicular to the folded edge, and remove the pins that were holding the fold. Stitch the pleat, leaving a gap in the stitching as described in 2-4 on page 78 of *TAoK* if your kilt will have a buttonhole (but **ignore** the bold type about folding pleat #3).
- 6 Repeat with the remaining pleats. If you are working with two pieces of tartan, just add the second piece when you get to it. You will stitch the join later.

Stitching the last pleat

After you have made the last pleat, stitch the last pleat edge along the chalk line of the underapron according to instructions 1-4 on pages 80-81 of *TAoK*.

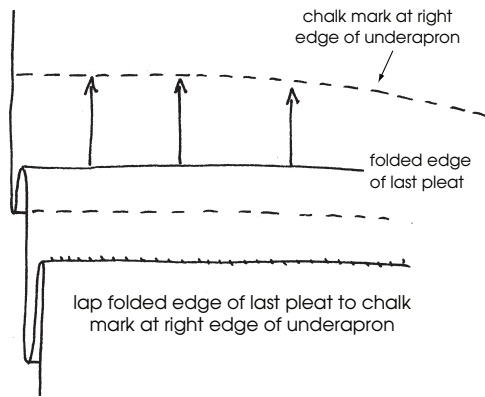

Stitching the join (if you used two pieces of tartan)

To make a hidden join, follow the instructions on pages 82-83 of *TAoK*. Just remember that the pleats will be folded into boxes, with half of the pleat on each side of the line of stitching rather than all folded in one direction. Be sure to place the join somewhere other than where the pleat will fold.

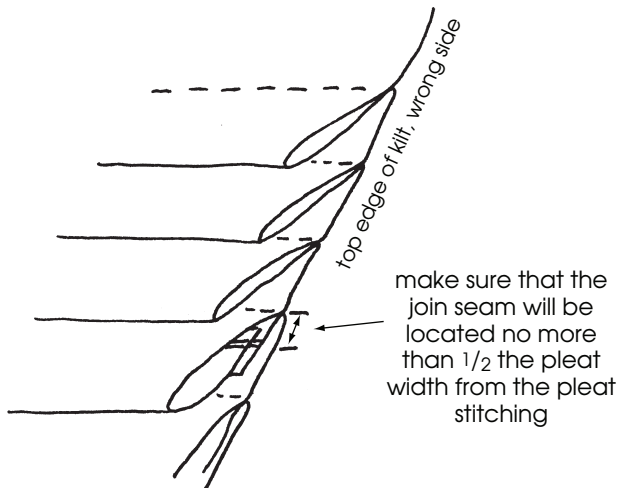

Finishing the bottom edge of the kilt

Follow instructions 1-3 on pages 83 to turn up the underapron edge of the kilt to keep it from hanging below the apron of the kilt.

Turn the kilt to the front, and go to the center of the first pleat at the bottom edge of the kilt. Measure $\frac{1}{2}$ of the pleat spacing from the center of the first pleat toward the apron, and put a pin in at the selvedge.

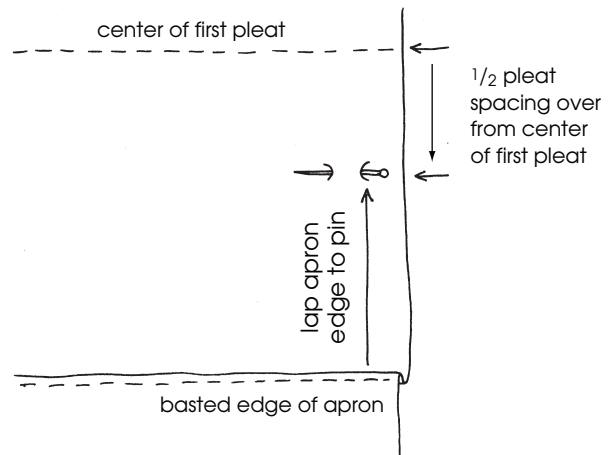

Bring the apron edge to the pin. Pinch and hold the apron edge at the pin, and locate the middle of the deep pleat behind the apron edge.

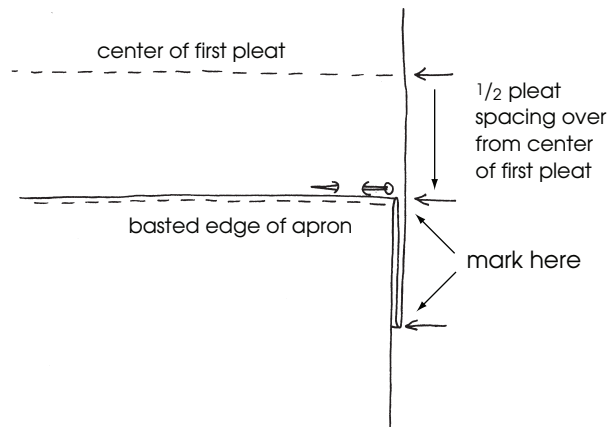

Mark the midpoint of the deep pleat with a pin or chalk. Follow instruction 5 on page 84 in *TAoK* to turn up a small hem in the deep pleat so that it doesn't hang out under the edge of the apron.

Completing the inverted pleat

Follow instructions 1-6 on pages 85-86 in *TAoK* to put a dart behind the inverted pleat and to baste the right hand edge of the underapron.

Basting the pleats

Turn the kilt over, and lay it on an ironing board with the top edge toward you, with the unstitched parts of the pleats hanging over the edge of the ironing board away from you and the inside facing up so that you can arrange the pleat boxes in the fell. The diagram at the top of page 29 illustrates the following steps.

- 1 Flatten each pleat loop to form a box centered on the pleat stitching below. You can feel the "ditch" through the back of the pleat so that you can center each perfectly.

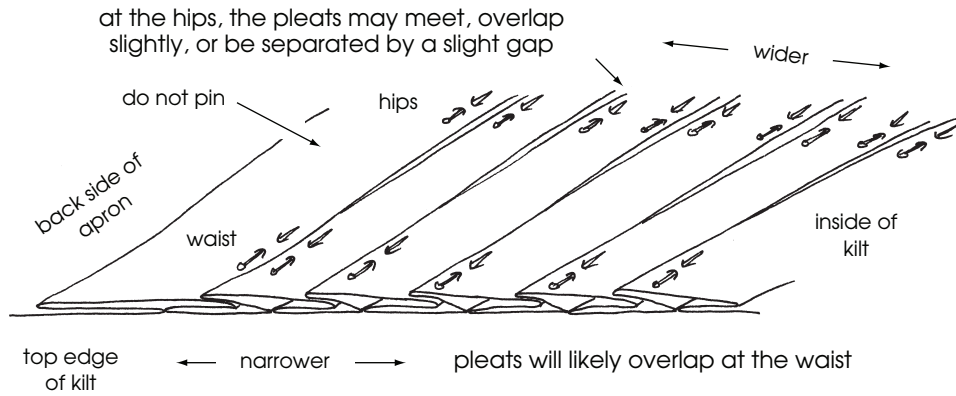

- 2 If the pleats are smaller at the waist than at the hips, the boxes will likely overlap at the waist. At the bottom of the fell, they may meet perfectly or they may have a slight gap.
- 3 As you fold each box, lightly steam press the boxes in the fell, but do not press below the bottom of the fell.
- 4 Pin the boxes in place at the waist and at the bottom of the fell. You can also run a line of basting along the top edge to hold the pleats in place.

You'll now baste the pleats to keep them in place for pressing. Leave the pins in to hold the pleats in place in the fell. Flip the kilt over to the right side, and lay it on a table with the top edge to the left. The pleats are basted with the same width at the bottom of the kilt as at the bottom of the fell. Below the bottom of the fell, the pleats are absolutely parallel, rather than splayed. The unfortunate consequences of basting splayed pleats are illustrated on page 86 of *TAoK*.

At the bottom edge of the kilt, locate the center of the first pleat. Measure $\frac{1}{2}$ the pleat spacing toward the apron from the pleat center, and put a pin at the selvage edge. Lap the basted apron edge to the pin.

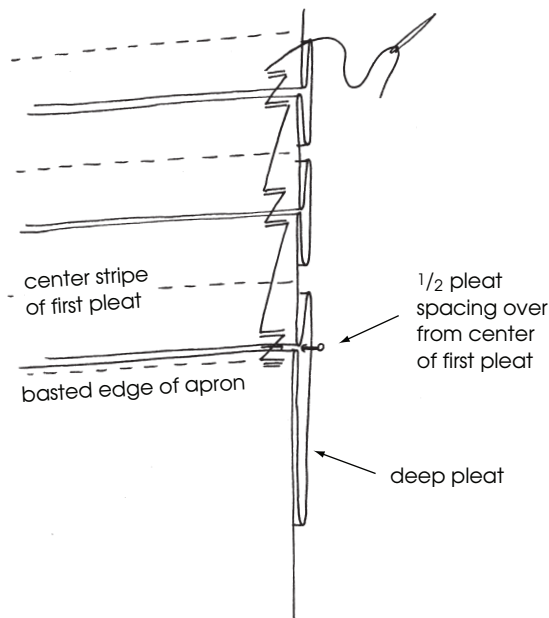

Make two large basting stitches through all three thicknesses. Fold the near edge of the first pleat in the correct spot using your pleat gauge (the same gauge that you used for the hip measurement), and bring it towards you until it meets the edge of the apron. Carry the thread from the previous stitching, and take two stitches through all thicknesses.

Locate the point midway between this pleat and the next one, and mark it with a pin. Fold the far edge of the first pleat at the mark on the gauge, and bring it to the pin. Carry the thread from the previous stitching, and make two basting stitches through all thicknesses. Fold the near edge of pleat two at the correct spot, and bring it towards you until it meets the far edge of the first pleat. Add two more basting stitches.

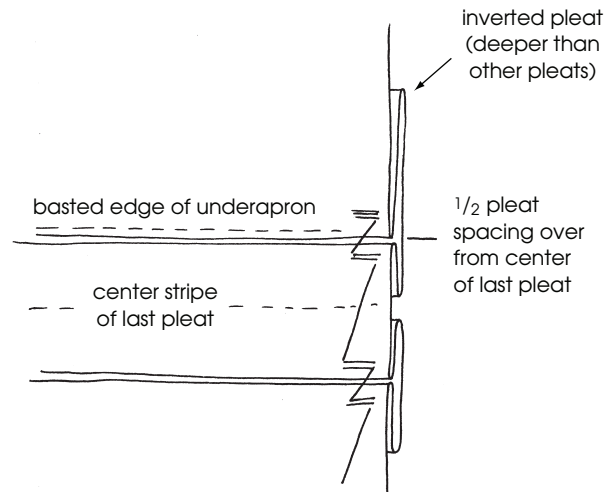

Work your way along the bottom of the kilt, basting all pleats. When you get to the underapron edge, the fold behind the underapron edge will be bigger than those at the other pleats.

Add another row of basting stitches about 2-3 fingers down from the bottom of the fell. Add two more rows between the top and bottom rows of basting.

Turn the kilt over, and baste one more time along the bottom of the kilt from the back side, starting at the underapron edge (top drawing, next page).

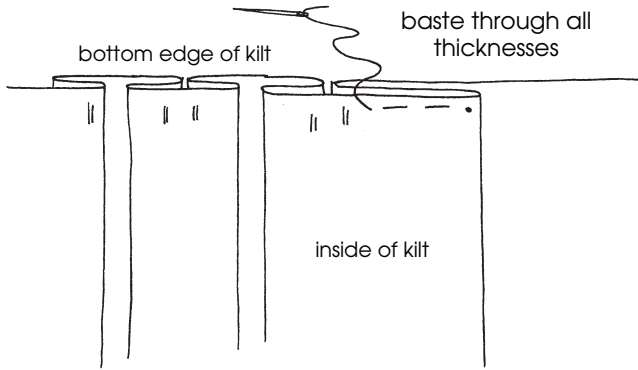

When you reach the dip in the hem at the edge of the apron, be sure that you don't align the dip with the bottom of the kilt, because the point of the deep pleat is about $\frac{3}{8}$ " shorter than the rest of the kilt. Match the stripes in the deep pleat with those in the apron. When you have finished basting, it should look like the pictures at right.

*****Continue to leave in the pins that are holding the pleats in the fell.**

Note: if you have previously made a knife pleated kilt, you cut out the pleats above the bottom of the fell to reduce bulk. Pleats are **NOT** cut out in a box pleated kilt, because the fell is much less bulky.

Shaping the right underapron and left apron

Follow instructions 1-6 on page 88-89 of *TAoK* for shaping the right edge of the underapron. Repeat these instructions in mirror image for the left edge of the apron. Continue to leave the pins in that are holding the pleats in the fell. After shaping the apron and underapron, your kilt should look like the picture below.



Doing the steeking

The pleats need to be stabilized just above the bottom of the fell, and a set of stitches called "steeking"



accomplishes this. Steeking is done from the wrong side of the kilt, and stitches must not be visible from the right side of the kilt.

Leaving in the pins that are holding the pleats in the fell, turn the kilt over to the wrong side, with the top edge away from you, rather than to the right or left. Thread a needle with carpet thread. Wax and knot the thread, and put the needle where you can reach it easily.

The first line of steeking is worked from right to left, along a line at the bottom of the fell. Start the first

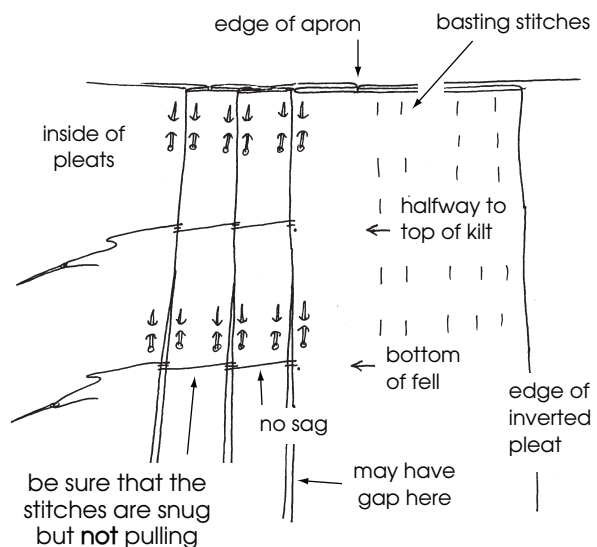

stitch at the left edge of the first pleat. Take another stitch to anchor the thread.

- 1 If the pleats meet or overlap at the bottom of the fell, tack the edge of the first pleat to the edge of the second pleat with a couple of stitches.
- 2 If there is a gap between the pleats at the bottom of the fell, tack the two pleats together with a couple of stitches that loop across the gap. Be sure not to pull the gap closed, or there will be a pucker on the front of the kilt. Use your hand underneath to make sure that the kilt remains smooth and extended but not stretched.
- 3 Be sure not to catch in the front side of the kilt! Check the front side of the kilt often as you do the steeking. If you see a dimple, pull the offending stitches out and re-do them. No amount of pressing will hide these dimples!

Once you have tacked the first two pleats together, carry the thread across the pleat to the left and repeat the process at the edges of the next pleats. Be sure that the carried thread is straight and snug but does not pucker the back of the pleat. Use your hand underneath to make sure that the kilt remains smooth and extended but not stretched. If you turn the kilt over, you'll see that the carried thread keeps stress from being placed on the pleat stitching at the bottom of the fell. **If it's slack or baggy, it's not doing its job.**

Work the steeking to the left across the kilt at the bottom of the fell, ending at the last pleat. Work a second line of steeking about halfway from the bottom of the fell to the top of the kilt. If the pleats overlap, tack the overlapping pleats together with a couple of stitches. **Check often for dimples.** If you see any, take the stitching out, and re-do it. Remove the pins that have held the pleats in the fell.



Attaching the stabilizer

You will now attach a stabilizer (photo above) inside the kilt at the waistline to keep the pleats from stretching and to reduce the stress on the pleat stitching.

- If your kilt does not have a buttonhole, apply the stabilizer following the instructions on pages 93-94 of *TAoK*, **except** 1) ignore references to the buttonhole and the inverted pleat and 2) start the stabilizer adjacent to the edge of the apron and extend it just to the under-apron at the other side of the pleats.

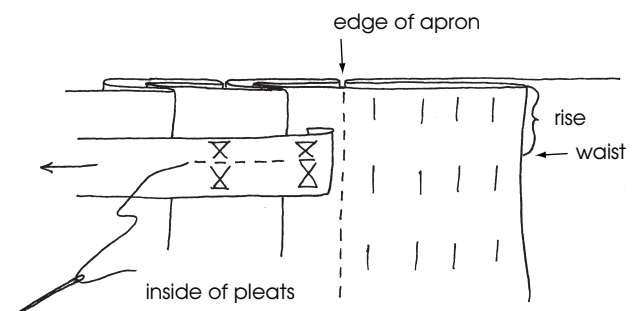

- If your kilt has a buttonhole, slit the back of the pleat directly behind the gap in pleat stitching that you left for the buttonhole. Extend the slit down about 4" from the top of the kilt. Clip carefully from the slit toward the pleat stitching on both sides so the you can open the pleat up flat to reveal the buttonhole. Fold two 2" squares of canvas interfacing, and slide one into each fold next to the buttonhole. Baste the flaps and canvas in place. Put the stabilizer on following the instructions on pages 93-94 of *TAoK*.

Applying the apron and underapron canvas

Canvas helps stiffen and support the upper edges of the apron and underapron. Apply canvas in the apron and underapron according to the instructions on pages 94-96 of *TAoK*.

Applying the canvas in the pleats

You will need to decide whether you want to have partial canvas or full canvas in the pleats. A box pleated kilt made from heavy weight tartan does not require the support of full canvas in the fell because the extra material is not cut out of the pleats, as it is in a traditional knife pleated kilt. If you are happy with the stiffness of the fell of your kilt, you can simply add a narrow line of canvas at the waist in the pleats. Alternatively, if you would like additional stiffness and support in the pleats of your kilt, particularly if you have made your kilt from lighter weight tartan, you can add the full canvas that is typical of a knife pleated kilt.

Apply canvas to stabilize the pleats following the instructions on pages 96-97 of *TAoK*, **except:**

- If you are putting in a narrow line of canvas at the waist (as shown in the first drawing below), use a piece of canvas 3" wide, but do not pleat the canvas. Also ignore references to the buttonhole unless your kilt has a buttonhole.

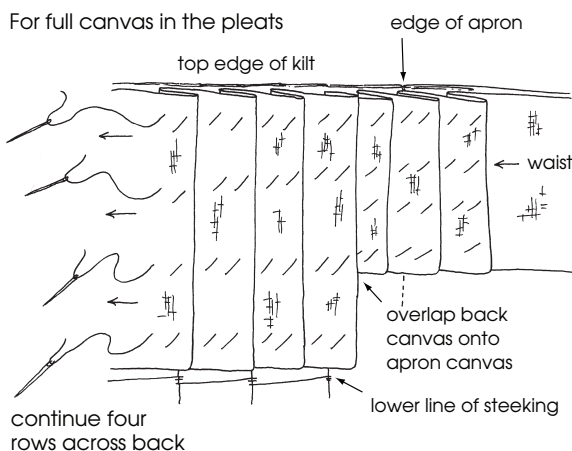
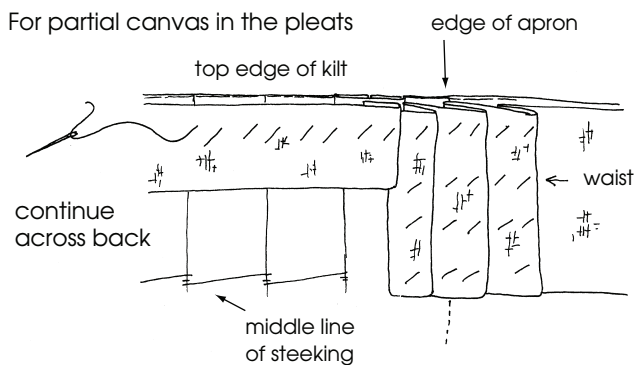

- If you are putting in full canvas (as shown in the second drawing at left), measure the distance from the top of the kilt to the bottom of the fell in order to determine the width of the piece of canvas to cut. Align the bottom of the canvas with the bottom line of steeking. Also ignore references to the buttonhole unless your kilt has a buttonhole.

If your kilt has a buttonhole, open the buttonhole in the canvas interfacing as described in step 1 on page 97 of *TAoK*.

Finishing the apron and underapron edges and applying the top band

Finish the underapron edge according to the instructions on page 98 of *TAoK*.

Many 18th century box pleated kilts did not have a fringe on the apron edge. If you do not want a fringe on the apron edge, finish the apron edge in the same way that you finished the underapron edge. On the other hand, if you would like your kilt to have a fringe on the apron edge, follow the instructions on finishing the apron edge on pages 99-100 of *TAoK*.

Finish the facing and apply the top band following the instructions on pages 101-103 of *TAoK*, ignoring the section on reinforcing the buttonhole unless your kilt has a buttonhole.

Pressing the kilt

Follow the instructions for pressing your kilt on page 103 of *TAoK*, **except be sure to press the pleats lightly**. If you lean on the iron and press as hard as you would normally press a knife pleated kilt, you will wind up with the inside edges of the pleats ghosting through to the top faces of the pleats. If there is any gap between the boxes on the inside of the kilt, you will also have a groove up the center of the top face of each pleat if you press the dickens out of your kilt. Use a light hand on your iron.

Attaching buckles and straps

If your kilt has a buttonhole, follow the instructions on pages 105-108 in *TAoK* for attaching buckles and straps.

If your kilt does not have a buttonhole, you will put the apron edge buckle on in the same way as you would for a knife pleated kilt, but the underapron buckle and strap will be put on differently. Follow the instructions on pages 105-107 in *TAoK* to prepare the buckle tab and measure for the location of the apron strap buckle. Sew the buckle for the apron strap onto the kilt. Ignore references to the buckle for the underapron strap (located next to the buttonhole on a knife pleated kilt).

Make a chalk mark on the front side of the kilt 1" in from the edge of the underapron at the waistline. The underapron buckle will be lined up with the chalk mark, with the buckle prong pointed toward the edge of the underapron. Make a buckle tab for the underapron buckle, and match the stripes and twill line to the underapron. Sew the buckle tab and buckle onto the front of the underapron as you did for the other buckle.

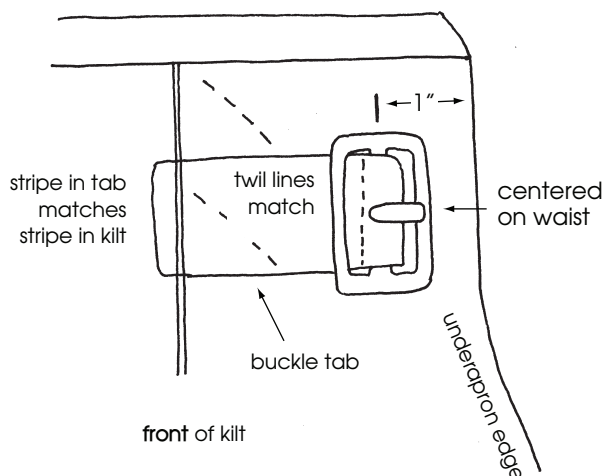

Prepare the kilt straps according to the instructions on page 107 of *TAoK*. Sew the apron strap on according to the instructions on page 108. You will wait to sew the underapron strap on until after you line the kilt.

Applying the lining

Apply the lining according to the instructions on pages 108-111 of *TAoK*, ignoring reference to the buttonhole unless your kilt has a buttonhole.

Sewing on the underapron strap

If your kilt does not have a buttonhole, the underapron strap is stitched to the **inside** of the kilt just to the left of the apron. Lay the lined kilt flat on the table with the inside facing up. Measure a distance equal to the waist measurement from the underapron edge across and into the pleats along the waistline. Make a chalk mark.

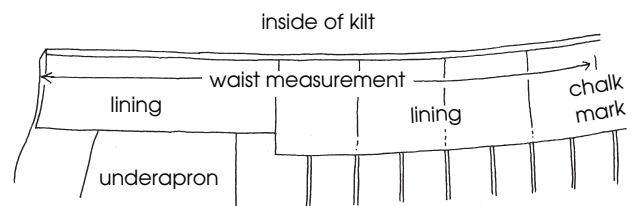

Fold the kilt in half inside out at the center back. Fold the apron under a bit, and wrap the underapron on top of the apron until it lies next to the chalk mark for the underapron strap. Fold back the edge so that the underapron buckle shows. Line up the top edges.

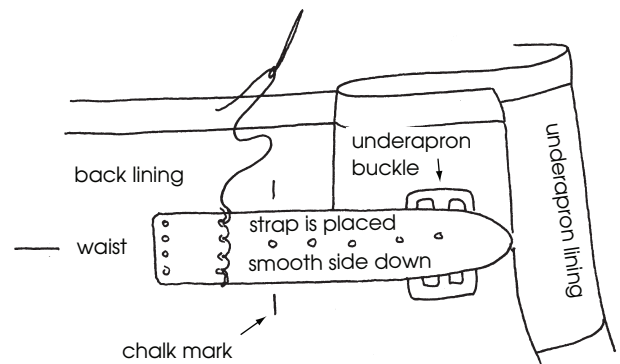

Lay the strap smooth side down against the kilt lining with point toward the underapron buckle. Line the first hole in the strap up with the chalk mark, and make sure that strap is aligned nice and straight with the buckle of the underapron. Stitch the strap on using instructions 4-6 on page 107 in *TAoK*, stitching through the lining, canvas, and backs of the pleats but being sure not to stitch through to the right side of the kilt.

Removing the basting

Remove the basting stitches carefully according to the instructions on page 111 of *TAoK*.

You're done!!!

Making a comfortable thimble for kiltmaking

Years ago, Dritz made a great leather thimble that really protected your finger, lasted a long time, and was a whole lot more comfortable and easy to use than a traditional metal thimble. Like many things, it's gone the way of the buffalo.

I finally got around to making a pattern from the very last one I had when it finally wore out, and I've made myself several more. They all work great. Here's how to make one:

- 1 Get a nice piece of heavy leather scrap (Michael's craft leather squares work great, if you want to buy a piece). Cut it out using the photo at right as a shape guide. If you want to use the picture as a template, scale it so that the long dimension is 3½" or so. It needs to be long enough to go around your finger and overlap by about ¾". You might need a longer length than my template if you have big fingers.
- 2 Cut a piece of metal flashing (I used a scrap of roof flashing) half the length of the tab and slightly less wide.
- 3 Fold the tab over the metal and hot glue the whole thing together. The metal flashing is the key - if you just use leather, your needle will be poking through the leather into your finger after a kilt or two.
- 4 Put a tab of Velcro at each end of the strip to hold it closed. I found that hot glue doesn't hold very well, but the sticky-back Velcro really sticks all by itself. You can always stitch it if it comes loose.
- 5 Wrap it around your finger, and shape the tab to arch over the end of your finger.

Voila! A perfect, comfortable thimble that doesn't make your fingernails ache or your finger sweaty.

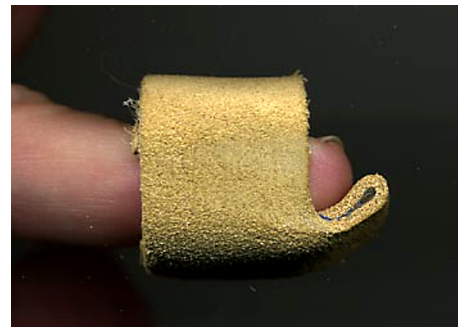
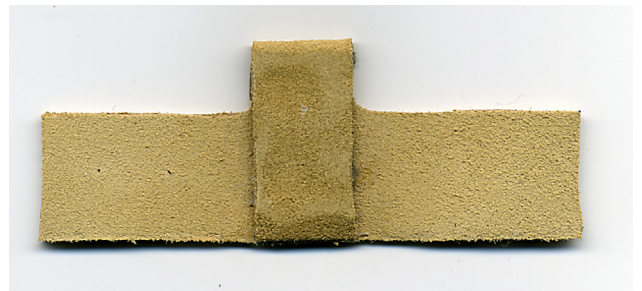
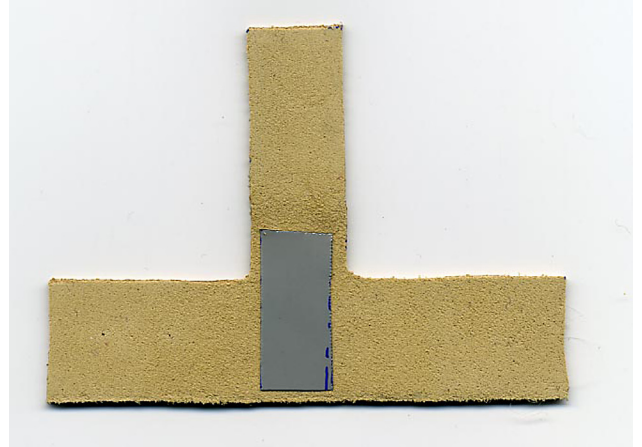

Making flashes from tartan scraps

The instructions below produce four flashes, two for each garter. You can match the tartan in all four, or make them in two sets of mirror image pairs. But, if you have a tartan with a big sett, this actually uses up quite a bit of tartan. If you have only a few scraps of tartan, you can certainly make non-matching flashes. For the flashes, you'll need:

- four 3" x 7" rectangles of tartan (7" is an approximate length and will make a finished flash that's about 5 3/4" long) - shorter or longer is OK)
- four 1 7/16" x 7" pieces of double-sided fusible web (see footnote below)
- four 5" lengths of black iron-on hem tape

If you need to make garters too, you'll need:

- two 18" lengths of 3/4" no-roll elastic
- two 4" lengths of 1/2" Velcro

- 1 Peel one side of the backing paper off a strip of fusible web.¹ Center it on one of the tartan rectangles; don't peel off the other paper. Iron the paper side of the web.
- 2 While the fabric is still warm, peel off the paper and fold the two sides of the tartan rectangle so that they meet in the center of the back of the flash. Press with your fingers to stick the edges down. Press the flash well with the iron.
- 3 Lay the piece of iron-on hem tape over the join on the back side of the flash, having the end even with the lower edge of the flash (the tape doesn't need to go to the top of the flash because you'll fold it over). Iron the hem tape.
- 4 Zig-zag the top raw edge of the flash, if you want. Then fold the top edge over about 1 1/4", and stitch close to the zig-zagged edge. [Note: If you don't have a sewing machine, you can cut another little strip of fusible web, slip it under the edge of the flash, and stick it together with the iron. Just be sure to leave enough of a channel for the garter.] Cut a notch out of the bottom edge of the flash.
- 5 A little Fray-Check helps keep the points from raveling and getting fuzzy.

- 6 If you need to make garters, too, stitch the hook and loop parts of the Velcro to opposite ends of the lengths of elastic. Make sure that you put the hooks on one side and the loops on the other. String two flashes on each garter. You're done!



¹These instructions call for double-sided fusible web, an iron-on material that is heat activated on both sides (unlike fusible interfacing, which is heat activated on only one side). Lots of different double-sided fusible materials are available. Some don't stick very well to tartan. Some types aren't readily available in strips that are wide enough (about 1 1/2") to make good flashes (e.g., Stitch Witchery is great, but the widest that's available is 1 1/4"). And lots of fusible materials are too heavy and make flashes that are very stiff. Lite Steam-A-Seam 2 brand double-fusible web irons well to tartan and also has the convenience of sticking temporarily before ironing. Flashes made with Lite Steam-A-Seam 2 are stiff enough to be attractive but retain a nice flexibility. It's available at Joann Fabrics stores and at www.JoAnn.com.

About the Authors



Dr. Barbara Jarvis Tewksbury has an unlikely background for an author and illustrator of a book on kiltmaking. She has a PhD in Geology and

has been professor of geology at Hamilton College in Clinton, New York for 30 years. She has received national recognition for teaching and curriculum development, served as President of both the National Association of Geoscience Teachers and the American Geological Institute, and was named 1997 Professor of the Year in New York State by the Carnegie Foundation for the Advancement of Teaching. Geology is not her whole life, however. Barb has a lifetime of interest in hand crafts and construction projects of all kinds. She is a skilled seamstress whose projects have won many awards, including numerous blue ribbons and a Best in Show prize at the New York State Fair. When her daughter, Carolyn, attended her first Scottish Highland dance camp in 1996, Barb went along to learn kiltmaking from Elsie Stuehmeyer. In five short days, Barb was hooked. The precision and complexity of the process appealed to her more than any other hand craft ever had. She has been making kilts ever since, squeezing time for making custom-made kilts into the spaces of a life already crammed with a family and a full-time professorship. She has made kilts for people as far away as Baghdad, and, in her spare time, she has also become a pretty decent piper. Barb wrote and illustrated *The Art of Kiltmaking* when Elsie asked her if she would collaborate on a book on kiltmaking, with Barb translating Elsie's lifetime of experience into instructions for a neophyte. Matt generously taught Barb how to make box pleated kilts in 2006.



Matthew A. C. Newsome has studied -- and worn -- kilts from all different periods of Scotland's history for many years. He has served as curator

of the Scottish Tartans Museum (US extension in Franklin, NC) since 1997. In October of 2004, he was inducted into the Guild of Tartan Scholars, and on November 30 (St. Andrews Day) of 2004, he was elected a Fellow of the Society of Antiquaries of Scotland. He is also a life member of the Scottish Tartans Authority. He is the author of *Early Highland Dress* (2003) and, with James A. Bullman, the *Compendium of District Tartans* (2004), both published by Scotpress. He also writes a monthly column for *The Scottish Banner* newspaper. Matt learned the art of making traditional box pleated kilts from kilt maker and historian Bob Martin and has made several hundred traditional box pleated kilts over the past several years. Matt has designed numerous tartans for individuals, families and institutions, including Virginia Tech, the University of Georgia, and the internet forum xmarksthescot.com. He holds a B.A. in English Literature from Western Carolina University and an M.A. in Theology from Holy Apostles College & Seminary, both summa cum laude. He has written articles for Catholic magazines *This Rock* and *Envoy* and is a frequent guest on the radio program, *Searching the Word on Relevant Radio*. He also serves as campus minister at Western Carolina University for the Roman Catholic Diocese of Charlotte. He lives in the mountains of western North Carolina with his wife, Joannie, and their four children. His web site is www.albanach.org.

